

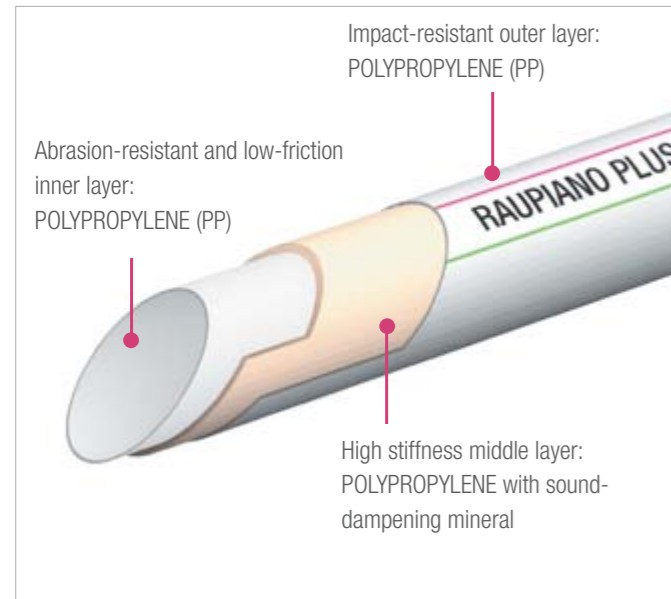

RAUPIANO PLUS

THE VERSATILE ACOUSTIC DRAINAGE SYSTEM
PRODUCT BOOK

RAUPIANO PLUS ACOUSTIC DRAINAGE SYSTEM



RAUPIANO PLUS represents the smart and versatile acoustic drainage system that provides optimum comfort without compromise. The polypropylene-based drainage system is suitable in a wide range of building types, from comfortable homes, modern hospitals, and hectic commercial kitchens to contemporary skyscrapers.

Its multi-layer pipe construction increases the pipe rigidity and enhances the sound insulation properties. The smooth yet abrasion-resistant inner layer optimizes the flow, while the impact-resistant outer layer provides robustness for handling on construction sites. Not only built with excellent quality the RAUPIANO PLUS system contains no toxic materials and is 100% recyclable.

RAUPIANO PLUS' excellent properties and complete product range allows you to fulfil the futures' requirements today.

FEATURES:

- Multi-layer pipe system:
 - Smooth yet abrasion-resistant inner layer made of PP
 - Rigid middle layer made of PP with sound-dampening minerals
 - Impact resistance and UV-stabilized outer layer made of PP
- Optimized mass-concentration for bend fittings to minimise fluid impact noise
- Patented sound-dampening brackets to minimise structural-borne sound transmission
- Built-in push-fit socket with factory-fitted sealing ring providing flexible and vibration-resistant joints
- Temperature resistance up to 95°C
- Chemical resistance from pH 2 – 12
- High ring stiffness
- 100% recyclable

ADVANTAGES:

- State-of-the-art sound insulation technologies, no acoustic-lagging required
- Suitable for special applications requiring high temperature and chemical resistance such as trade waste
- Green system due to low energy production and 100% recyclability
- Simple and fast installation
- No special provision required to accommodate thermal expansion
- Robust for transportation and handling at construction sites
- 100% leak-proof connection
- Flexible joint suitable for tremor-prone areas
- Uncompromising fire-protection solutions available

TABLE OF CONTENTS

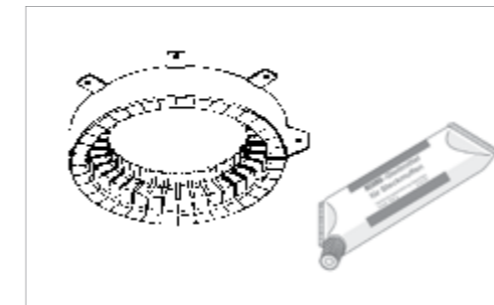
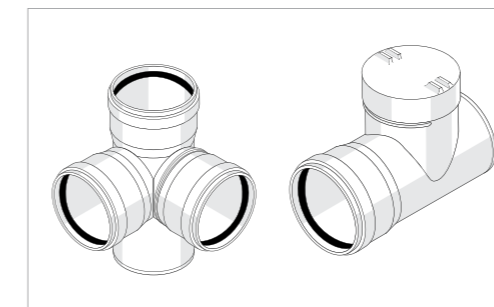
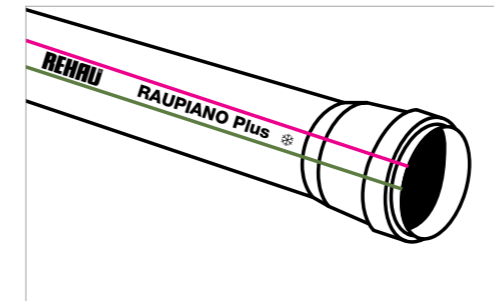

	Page
1. PIPES.....	4
2. FITTINGS.....	6
3. ACCESSORIES.....	15
4. ORDER CHECKLIST	20

1. PIPES

Pipes
With push-fit socket and rubber sealing ring
Material: RAU-PP (mineral reinforced)
Colour: white (similar to RAL 9003)

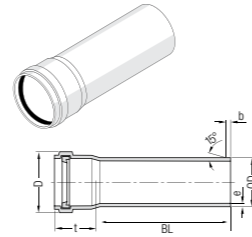

Article	REECE Codes	DN/OD in mm	e	Length BL	Unit
123004	-	40	1.8	150	piece
123014	1450819	40	1.8	250	piece
123024	1450820	40	1.8	500	piece
123034	1450821	40	1.8	1000	piece
123044	-	40	1.8	2000	piece
123054	1450823	40	1.8	3000	piece
120094	-	50	1.8	150	piece
120104	1450825	50	1.8	250	piece
120114	1450826	50	1.8	500	piece
120124	-	50	1.8	750	piece
120134	1450828	50	1.8	1000	piece
120144	-	50	1.8	1500	piece
120154	-	50	1.8	2000	piece
120934	1450831	50	1.8	3000	piece
120174	-	75	1.9	150	piece
120184	1450833	75	1.9	250	piece
120194	1450834	75	1.9	500	piece
120204	-	75	1.9	750	piece
120214	1450836	75	1.9	1000	piece
120224	-	75	1.9	1500	piece
120234	-	75	1.9	2000	piece
120944	1450839	75	1.9	3000	piece
123984	-	90	2.2	150	piece
123184	-	90	2.2	250	piece
123194	-	90	2.2	500	piece
123204	-	90	2.2	1000	piece
123994	-	90	2.2	1500	piece
123214	-	90	2.2	2000	piece
123224	-	90	2.2	3000	piece
120254	-	110	2.7	150	piece
120264	1450848	110	2.7	250	piece
120274	1450849	110	2.7	500	piece
120284	-	110	2.7	750	piece
120294	1450851	110	2.7	1000	piece
120304	-	110	2.7	1500	piece
120314	-	110	2.7	2000	piece

Article	REECE Codes	DN/OD in mm	e	Length	Unit
120324	1450854	110	2.7	3000	piece
120654	-	125	3.1	150	piece
120664	-	125	3.1	250	piece
120674	-	125	3.1	500	piece
120684	-	125	3.1	750	piece
120694	-	125	3.1	1000	piece
120704	-	125	3.1	1500	piece
120714	-	125	3.1	2000	piece
120724	-	125	3.1	3000	piece
122954	1450863	160	3.9	500	piece
121664	1450864	160	3.9	1000	piece
121674	-	160	3.9	2000	piece
121684	1450866	160	3.9	3000	piece
123015	-	200	6.2	1000	piece
123025	-	200	6.2	2000	piece
123035	-	200	6.2	3000	piece

2. FITTINGS

Bend
With rubber sealing ring
Material: RAU-PP (mineral reinforced)
Colour: white (similar to RAL 9003)

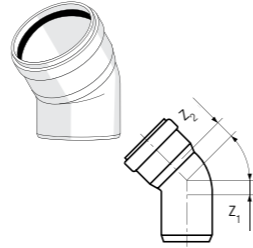

Article	REECE Codes	DN in mm	Angle ∞	Z ₁	Z ₂	Unit
123064	1450724	40	15°	5	8	piece
123074	1450725	40	30°	7	11	piece
123084	1450726	40	45°	10	14	piece
100504 ⁽¹⁾	1450727	40	87°	23	26	piece
121094	1450728	50	15°	5	9	piece
121104	1450729	50	30°	9	12	piece
121114	1450730	50	45°	12	16	piece
121124	-	50	67°	20	23	piece
100506 ⁽¹⁾	1450732	50	87°	28	31	piece
121144	1450733	75	15°	7	11	piece
121154	1450734	75	30°	12	15	piece
121164	1450735	75	45°	20	21	piece
121174	-	75	67°	28	31	piece
100507 ⁽¹⁾	1450737	75	87°	40	43	piece
123384	-	90	15°	7	12	piece
123394	-	90	30°	14	18	piece
123404	-	90	45°	21	25	piece
100515 ⁽¹⁾	-	90	87°	48	52	piece
123424	1450710	110	15°	9	14	piece
123434	1450711	110	30°	17	21	piece
123444	1450712	110	45°	25	29	piece
123454	-	110	67°	40	44	piece
100534 ⁽¹⁾	1450714	110	87°	57	61	piece
123474	-	125	15°	10	15	piece
123484	-	125	30°	19	23	piece
123494	-	125	45°	28	33	piece
123504	-	125	67°	46	50	piece
123514 ⁽¹⁾	-	125	87°	65	70	piece
124028	1450720	160	45°	38	42	piece
124029 ⁽¹⁾	1450721	160	87°	87	87	piece
123654	-	200	45°	46	63	piece
123664 ⁽¹⁾	-	200	87°	105	122	piece

Note: ⁽¹⁾ Swept bend

Single Branch
With rubber sealing ring
Material: RAU-PP (mineral reinforced)
Colour: white (similar to RAL 9003)

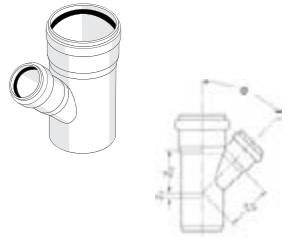

Article	REECE Codes	DN in mm	Angle ∞	Z ₁	Z ₂	Z ₃	Unit
123104	1450902	40/40	45°	10	49	49	piece
123114	1450903	40/40	87°	23	25	25	piece
121234	1450904	50/50	45°	12	61	61	piece
121254	1450905	50/50	87°	28	30	30	piece
121264	1450906	75/50	45°	-1	79	74	piece
121284	1450907	75/50	87°	27	43	31	piece
121294	1450908	75/75	45°	18	91	91	piece
121544	1450909	75/75	87°	40	43	43	piece
123274	-	90/50	45°	-8	90	83	piece
123284	-	90/50	87°	28	50	32	piece
123834	-	90/75	45°	11	102	100	piece
123844	-	90/75	87°	41	51	44	piece
123294	-	90/90	45°	21	110	110	piece
123304 ⁽¹⁾	-	90/90	87°	56	70	51	piece
121304	1450916	110/50	45°	-17	104	91	piece
121324	1450917	110/50	87°	28	60	32	piece
121334	1450918	110/75	45°	1	116	109	piece
121344	1450919	110/75	87°	40	60	45	piece
122984	1450920	110/110	45°	25	134	134	piece
123005 ⁽¹⁾	1450921	110/110	87°	73	78	58	piece
120574	-	125/110	45°	18	144	141	piece
120594	-	125/110	87°	58	69	63	piece
120584	-	125/125	45°	28	152	152	piece
120604	-	125/125	87°	65	70	70	piece
124037	1450926	160/110	45°	36	169	197	piece
121744	1450927	160/110	87°	105	140	70	piece
121754	-	160/125	45°	12	176	169	piece
121764	-	160/125	87°	66	87	71	piece
124038	1450930	160/160	45°	36	197	197	piece
124058	1450931	160/160	87°	83	89	89	piece
123964	-	200/160	45°	47	245	255	piece
123704	-	200/160	87°	154	200	145	piece
123964	-	200/200	45°	47	255	255	piece

Note: ⁽¹⁾ Swept angle

2. FITTINGS

Double Branch
With rubber sealing rings
Material: RAU-PP (mineral reinforced)
Colour: white (similar to RAL 9003)

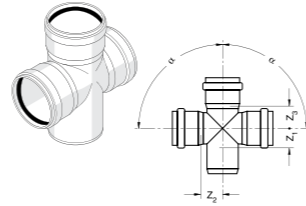

Article	REECE Codes	DN in mm	Angle	Z ₁	Z ₂	Z ₃	Unit
123714	-	90/90/90	87°	56	70	51	piece
122964	1450756	110/110/110	45°	25	134	134	piece
121554	1450757	110/110/110	87°	57	62	62	piece
123594	-	125/110/110	45°	18	144	141	piece
123674	1450759	160/110/110	45°	1	168	159	piece
123684	-	160/110/110	87°	58	86	64	piece

Corner Double Branch
With rubber sealing rings
Material: RAU-PP (mineral reinforced)
Colour: white (similar to RAL 9003)

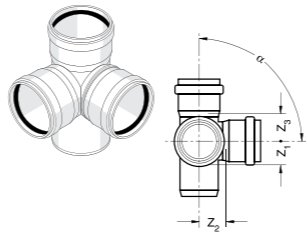

Article	REECE Codes	DN in mm	Angle	Z ₁	Z ₁	Z ₁	Unit
123724	-	90/90/90	87°	56	70	66	piece
121564	-	110/110/110	87°	57	62	62	piece

Shaft Branch Right
With rubber sealing rings
Material: RAU-PP (mineral reinforced)
Colour: white (similar to RAL 9003)

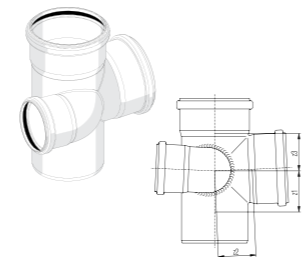

Article	REECE Codes	DN in mm	Angle	Z ₁	Z ₂	Z ₃	Z ₄	Unit
123045	-	90/75/90	87°	56	70	51	46	piece
123761	-	110/75/110	87°	57	62	62	63	piece

Shaft Branch Left
With rubber sealing rings
Material: RAU-PP (mineral reinforced)
Colour: white (similar to RAL 9003)

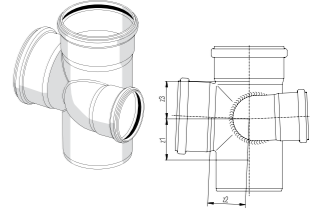

Article	REECE Codes	DN in mm	Angle	Z ₁	Z ₂	Z ₃	Z ₄	Unit
123055	-	90/75/90	87°	56	70	51	46	piece
123771	-	110/75/110	87°	57	62	62	63	piece

Parallel Branch
With rubber sealing rings
Material: RAU-PP (mineral reinforced)
Colour: white (similar to RAL 9003)

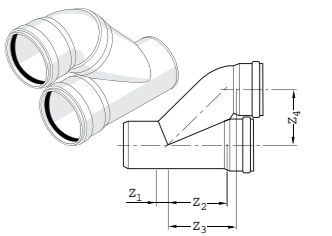

Article	REECE Codes	DN in mm	Z ₁	Z ₂	Z ₃	Z ₄	Unit
123734	-	90/90	21	110	125	108	piece
120564	-	110/110	25	134	149	118	piece

Deflection Bend (45° and 87°)
With built-in push-fit socket and factory pre-assembled rubber sealing ring
Material: RAU-PP (mineral reinforced)
Colour: white (similar to RAL 9003)

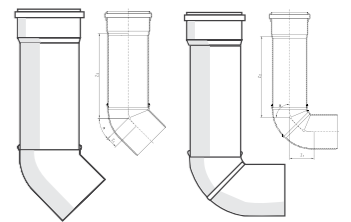

Article	REECE Codes	DN in mm	Angle	Z ₁	Z ₂	Unit
123056	1450762	75	45°	47	206	piece
123057	-	90	45°	56	210	piece
123058	1450766	110	45°	69	217	piece
123075	1450763	75	87°	47	204	piece
123085	-	90	87°	56	212	piece
123095	1450767	110	87°	69	226	piece

2. FITTINGS

Reducer
With rubber sealing ring
Material: RAU-PP (mineral reinforced)
Colour: white (similar to RAL 9003)

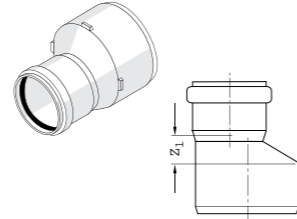

Article	REECE Codes	DN in mm	Z ₁	Unit
123124	1450871	50/40	12	piece
121384	1450872	75/50	20	piece
123314	-	90/50	29	piece
123324	-	90/75	15	piece
121394	1450875	110/50	40	piece
121404	1450876	110/75	26	piece
121994	-	110/90	20	piece
120614	-	125/110	15	piece
124039	1450879	160/110	33	piece
121804	-	160/125	27	piece
123764	-	200/160	40	piece

PVC Adaptor
Material: PVC
Colour: white

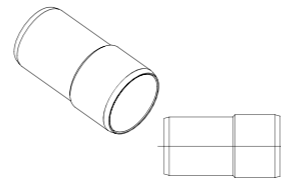

Article	REECE Codes	DN in mm	Unit
123009	1450706	40/43	piece
121012	1450707	50/52	piece
121016	1450708	75/69	piece
121017	-	90/82	piece

Connection Pipe
For connection to other pipe materials. To be used together with rubber nipple
Material: RAU-PP (mineral reinforced)
Colour: white (similar to RAL 9003)

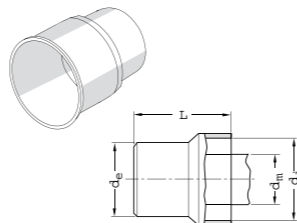

Article	REECE Codes	DN in mm	Metal pipe outer d _m	d _e	d _i	L	Unit
123164	1450752	40/40-30	32 - 40	40	53.7	63	piece
121414	1450753	50/40-30	32 - 40	50	53.7	61	piece
121424	1450754	50/50	47 - 50	50	67.2	50	piece

Connection Bend
For connection to other pipe materials. To be used together with rubber nipple
Material: RAU-PP (mineral reinforced)
Colour: white (similar to RAL 9003)

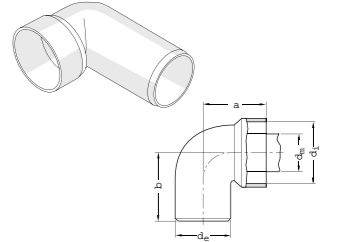

Article	REECE Codes	DN in mm	Metal pipe outer d _m	d _e	d _i	a	b	Unit
123174	-	40/40-30	32 - 40	40	53.7	49	88	piece
122694	-	50/40-30	32 - 40	50	53.7	55	90	piece
121444	-	50/50	47 - 50	50	67.2	55	96	piece

Socket Plug
Material: RAU-PP (mineral reinforced)
Colour: white (similar to RAL 9003)

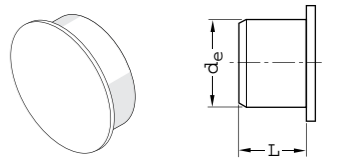

Article	REECE Codes	DN in mm	L	d _e	Unit
123134	1450943	40	33	40	piece
121454	1450944	50	34	50	piece
121464	1450945	75	35	75	piece
123334	-	90	37	90	piece
121474	1450947	110	37	110	piece
120624	-	125	40	125	piece
123774	1450949	160	49	160	piece
123974	-	200	59	200	piece

2. FITTINGS

Double Socket
With rubber sealing rings
Material: RAU-PP (mineral reinforced)
Colour: white (similar to RAL 9003)

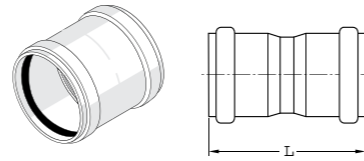

Article	REECE Codes	DN in mm	L	Unit
123144	1450768	40	89	piece
121484	1450769	50	93	piece
121584	1450770	75	111	piece
123344	-	90	107	piece
121494	1450772	110	128	piece
120474	-	125	142	piece
124047	1450774	160	148	piece
123784	-	200	206	piece

Slip-on Socket
With rubber sealing rings
Material: RAU-PP (mineral reinforced)
Colour: white (similar to RAL 9003)

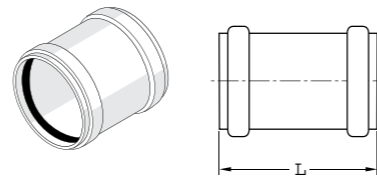

Article	REECE Codes	DN in mm	L	Unit
123154	1450935	40	89	piece
121504	1450936	50	93	piece
121574	1450937	75	111	piece
123354	-	90	107	piece
121514	1450939	110	128	piece
120464	-	125	142	piece
124048	1450941	160	148	piece
123794	-	200	206	piece

I.O. Access Pipe
With surface-flushing insert and screwed cap and rubber sealing ring
Material: RAU-PP (mineral reinforced)
Colour: white (similar to RAL 9003)

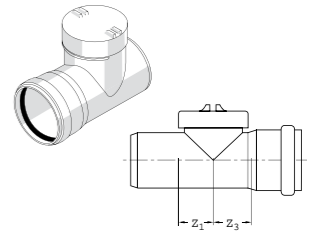

Article	REECE Codes	DN in mm	Z ₁	Z ₃	Unit
121235	1450805	50	28	30	piece
121524	1450806	75	40	43	piece
123364	-	90	57	64	piece
121534	1450808	110	57	62	piece
120634	-	125	70	73	piece
124049	1450810	160	83	89	piece

Long Socket
With rubber sealing ring
Material: RAU-PP (mineral reinforced)
Colour: white (similar to RAL 9003)

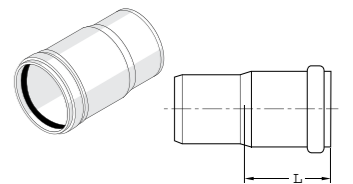

Article	REECE Codes	DN in mm	L	Unit
123374	-	90	120	piece
121594	1450812	110	130	piece

Closet Bend
With lip sealing ring
Material: RAU-PP (mineral reinforced)
Colour: white

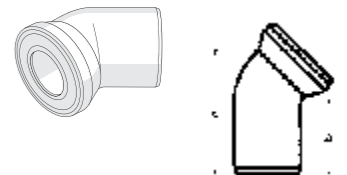

Article	REECE Codes	DN in mm	a	b	Unit
122924	-	90/90°	400	340	piece
121604	-	110/22°	165	150	piece
121614	-	110/45°	205	135	piece
121624	1450744	110/90°	230	160	piece

2. FITTINGS

Closet Connection
With lip sealing ring
Material: RAU-PP
Colour: white

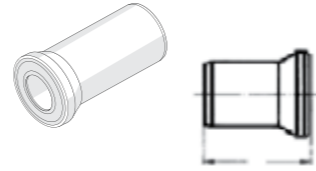

Article	REECE Codes	DN in mm	Length L	Unit
122934	-	90	250	piece
121634	1450746	110	150	piece
121644	1450747	110	250	piece

P-trap siphon
To be used together with DN 110 bend 45°. With rubber sealing ring

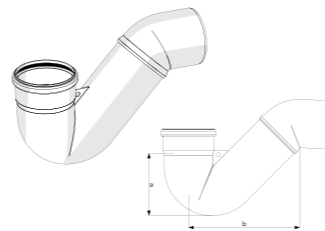

Article	REECE Codes	DN in mm	a	b	c	Unit
123039	1450870	110	-	-	-	piece

Floor Gully
With 3x DN 50 inlets + DN75 outlet. DN50 inlets require DN50 double socket
art. # 121484-001
Material: RAU-PP (mineral reinforced)
Colour: white (similar to RAL 9003)

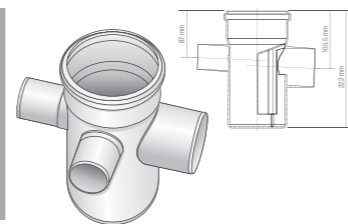

Article	REECE Codes	DN in mm	Z ₁	Z ₂	Z ₃	Unit
122974	-	50/50/50/75	175	87	67	piece

3. ACCESSORIES

Sound-dampening Support Bracket
Consisting of supporting and fastening clamp incl. headless screw
Material: galvanised strip steel

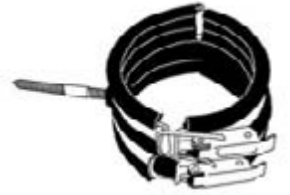

Article	REECE Codes	DN in mm	Unit
122004	1450954	75	piece
122044	-	90	piece
122014	1450956	110	piece
122024	-	125	piece
122034	1450958	160	piece
123924	-	200	piece

Fixing/Security Clamp
With rubber lining
Material: galvanised strip steel



Article	REECE Codes	DN in mm	Unit
122644	-	40	piece
120504	-	50	piece
120514	-	75	piece
122054	-	90	piece
120524	-	110	piece
120804	-	125	piece
121844	-	160	piece
123934	-	200	piece

3. ACCESSORIES

Guiding Clamp
With rubber lining and distance piece
Material: galvanised strip steel



Article	REECE Codes	DN in mm	Unit
122654	-	40	piece
120534	-	50	piece
120544	-	75	piece
122064	-	90	piece
120554	-	110	piece
120814	-	125	piece
121854	-	160	piece
123944	-	200	piece

Headless Screw
For fastening/guiding clamp



Article	REECE Codes	DN in mm	Unit
121074	-	M 8	piece
121084	-	M 10	piece

REHAU Fireproofing Collar Compact
For installation on the ceiling/wall
Material: steel sheet
Colour: white

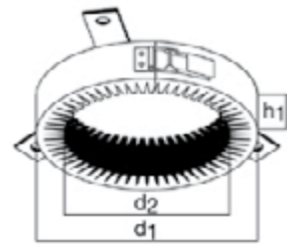

Article	REECE Codes	DN in mm	d ₁	d ₂	h ₁	Unit
122104	-	50	75	63	30	piece
122114	-	75	109	88	30	piece
122124	-	90	135	103	30	piece
122134	-	110	155	123	30	piece
122134	-	125	170	138	30	piece

Rehau Fireproofing Collar Plus
For flush mounting in the ceiling/wall or surface mounting on the ceiling/wall
Material: steel sheet
Colour: white

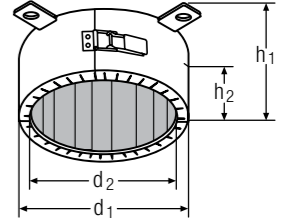

Article	REECE Codes	DN in mm	d ₁	d ₂	h ₁	h ₂	Unit
121894	-	40 - 50	68	57	50	15-35	piece
121904	-	75	99	82	50	15-35	piece
121914	-	90	118	97	70	25-45	piece
121924	-	110	139	117	70	25-45	piece
121934	-	125	161	132	70	25-45	piece
121944	-	160	198	167	110	45-65	piece
121008	-	200	247	207	120	50-70	piece

Rehau Angled Fireproofing Collar
For installation on the ceiling for angled penetrations
Material: steel sheet
Colour: white



Article	REECE Codes	DN in mm	d ₁	d ₂	d ₃	Unit
120834	-	75	191	121	30	piece
120874	-	90	216	136	42	piece
120844	-	110	236	156	42	piece
120854	-	125	264	184	42	piece

3. ACCESSORIES

Rubber Sealing Ring
For pipes and fittings
Material: rubber
Colour: black

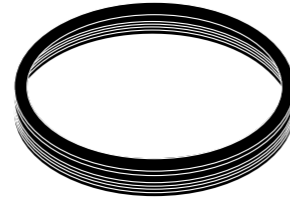

Article	REECE Codes	DN in mm	Unit
128243	1450887	40	piece
128013	1450888	50	piece
128023	1450889	75	piece
128003	-	90	piece
128033	1450891	110	piece
128043	-	125	piece
128053	1450893	160	piece

Rubber Nipple
For connection piece and siphon angle
Material: rubber
Colour: black

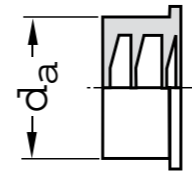

Article	REECE Codes	DN in mm	d_a	Unit
126253	1450882	50/40	55	piece
121913	1450883	50/50	68	piece

Rubber Nipple with Bead
For connection to other pipe materials. To replace the pre-assembled rubber sealing ring in RAUPIANO PLUS pipes or fittings.
Material: rubber
Colour: black

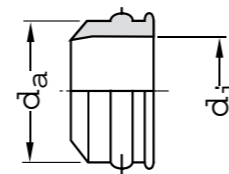

Article	REECE Codes	DN in mm	d_a	d_i	Unit
122923	1450884	40/30	40.5	32	piece
122933	1450885	50/30	50.5	32	piece
122943	1450886	50/40	50.5	40	piece

Rubber Sleeve Adaptor
For connection to different diameters
Material: rubber
Colour: black



Article	REECE Codes	DN in mm	Unit
125024	1450894	50/53-63	piece
125034	1450895	75/75-89	piece
123904	-	110/90	piece
123914	1450897	110/110	piece

Securing Clip
For securing the socket plug
Material: Galvanized steel
Colour: Silver

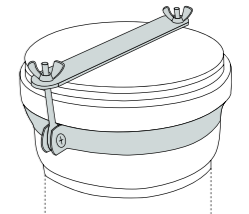

Article	REECE Codes	DN in mm	Unit
123000	1450951	110	piece
123002	1450952	160	piece
123006	-	200	piece

Lubricant
For push-fit connections



Article	REECE Codes	DN in mm	Unit
128933	1450813	150 g	piece
128943	1450814	250 g	piece
128953	1450815	500 g	piece

4. ORDER CHECKLIST

Article	Product	REECE codes	Quantity	Price
PIPES				
Pipes				
123004	40 - 150	-
123014	40 - 250	1450819
123024	40 - 500	1450820
123034	40 - 1000	1450821
123044	40 - 2000	-
123054	40 - 3000	1450823
120094	50 - 150	-
120104	50 - 250	1450825
120114	50 - 500	1450826
120124	50 - 750	-
120134	50 - 1000	1450828
120144	50 - 1500	-
120154	50 - 2000	-
120934	50 - 3000	1450831
120174	75 - 150	-
120184	75 - 250	1450833
120194	75 - 500	1450834
120204	75 - 750	-
120214	75 - 1000	1450836
120224	75 - 1500	-
120234	75 - 2000	-
120944	75 - 3000	1450839
123984	90 - 150	-
123184	90 - 250	-
123194	90 - 500	-
123204	90 - 1000	-
123994	90 - 1500	-
123214	90 - 2000	-
123224	90 - 3000	-
120254	110 - 150	-
120264	110 - 250	1450848
120274	110 - 500	1450849
120284	110 - 750	-
120294	110 - 1000	1450851
120304	110 - 1500	-
120314	110 - 2000	-
120324	110 - 3000	1450854
120654	125 - 150	-
120664	125 - 250	-
120674	125 - 500	-
120684	125 - 750	-
120694	125 - 1000	-
120704	125 - 1500	-
120714	125 - 2000	-
120724	125 - 3000	-
122954	160 - 500	1450863
121664	160 - 1000	1450864
121674	160 - 2000	-
121684	160 - 3000	1450866
123015	200 - 1000	-
123025	200 - 2000	-
123035	200 - 3000	-









Article	Product	REECE codes	Quantity	Price
FITTINGS				
Bend				
123064	40 - 15°	1450724
123074	40 - 30°	1450725
123084	40 - 45°	1450726
123094	40 - 87°	1450727
121094	50 - 15°	1450728
121104	50 - 30°	1450729
121114	50 - 45°	1450730
121124	50 - 67°	-
121134	50 - 87°	1450732
121144	75 - 15°	1450733
121154	75 - 30°	1450734
121164	75 - 45°	1450735
121174	75 - 67°	-
121184	75 - 87°	1450737
123384	90 - 15°	-
123394	90 - 30°	-
123404	90 - 45°	-
123414	90 - 87°	-
123474	125 - 15°	1450710
123434	110 - 30°	1450711
123444	110 - 45°	1450712
123454	110 - 67°	-
123464	110 - 87°	1450714
123474	125 - 15°	-
123484	125 - 30°	-
123494	125 - 45°	-
123504	125 - 67°	-
123514	125 - 87°	-
121714	160 - 45°	1450720
121724	160 - 87°	1450721
123654	200 - 45°	-
123664	200 - 87°	-
Single branch				
123104	40/40 - 45°	1450902
123114	40/40 - 87°	1450903
121234	50/50 - 45°	1450904
121254	50/50 - 87°	1450905
121264	75/50 - 45°	1450906
121284	75/50 - 87°	1450907
121294	75/75 - 45°	1450908
121544	75/75 - 87°	1450909
123274	90/50 - 45°	-
123284	90/50 - 87°	-
123294	90/90 - 45°	-
121324	110/50 - 87°	-
121334	110/75 - 45°	-
121344	110/75 - 87°	-
121354	110/110 - 45°	1450916
121374	110/110 - 87°	1450917
120574	125/110 - 45°	1450918
120594	125/110 - 87°	1450919
120604	125/125 - 45°	1450920
120604	125/125 - 87°	1450921
121734	160/110 - 45°	-
121744	160/110 - 87°	-











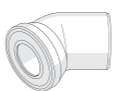



4. ORDER CHECKLIST

Article	Product	REECE codes	Quantity	Price	
Double branch (45° and 87°)					
Double branch - 45°					
122964	110/110/110	1450756	
123594	125/110/110	-	
123674	160/110/110	1450759	
Double branch - 87°					
123714	90/90/90	-	
121554	110/110/110	1450757	
123684	160/110/110	-	
Corner double branch					
123724	90/90/90	-	
121564	110/110/110	-	
Shaft branch right					
123045	90/75/90	-	
123761	110/75/110	-	
Shaft branch left					
123055	90/75/90	-	
123771	110/75/110	-	
Parallel branch					
123734	90/90	-	
120564	110/110	-	
Deflection bend (45° and 87°)					
Deflection bend - 45°					
123056	75	1450762	
123057	90	-	
123058	110	1450766	
Deflection bend - 87°					
123075	75	1450763	
123085	90	-	
123095	110	1450767	
Reducer					
123124	50/40	1450762	
121384	75/50	1450762	
123314	90/50	-	
123324	90/75	-	
121394	110/50	1450762	
121404	110/75	1450762	
121994	110/90	-	
120614	125/110	-	
124039	160/110	1450762	
121804	160/125	-	
123764	200/160	-	

Article	Product	REECE codes	Quantity	Price		
PVC adaptor						
123009	40/43	1450706		
123012	50/56	1450707		
123016	75/69	1450708		
123017	90/82	-		
Connection pipe						
123164	40/40-30	1450752		
121414	50/40-30	1450753		
121424	50/50	1450754		
Connection bend						
123174	40/40-30	-		
122694	50/40-30	-		
121444	50/50	-		
Socket plug						
123134	40	1450943		
121454	50	1450944		
121464	75	1450945		
123334	90	-		
121474	110	1450947		
120624	125	-		
123774	160	1450949		
123974	200	-		
Double socket						
123144	40	1450768		
121484	50	1450769		
121584	75	1450770		
123344	90	-		
121494	110	1450772		
120474	125	-		
124047	160	1450774		
123784	200	-		
Slip-on socket						
123154	40	1450935		
121504	50	1450936		
121574	75	1450937		
123354	90	-		
121514	110	1450939		
120464	125	-		
124048	160	1450941		
123794	200	-		
I.O. access pipe						
121235	50	1450805		
121524	75	1450806		
123364	90	-		
121534	110	1450808		
120634	125	-		
124049	160	1450810		

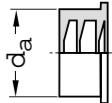
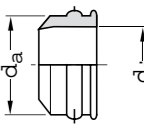
4. ORDER CHECKLIST

Article	Product	REECE codes	Quantity	Price	
Long socket					
123374	90	-	
121594	110	1450812	
Closet bend					
122924	90/90°	-	
121604	110/22°	-	
121614	110/45°	-	
121624	110/90°	1450744	
Closet connection					
122934	90	-	
121634	110	1450746	
121644	110	1450747	
P-trap siphon					
123039	110	1450870	
Floor gully					
100391	50/50/50/75	-	
ACCESSORIES					
Sound-dampening support bracket					
122004	75	1450954	
122044	90	-	
122014	110	1450956	
122024	125	-	
122034	160	1450958	
123924	200	-	
Fixing/security clamp					
122644	40	-	
120504	50	-	
120514	75	-	
122054	90	-	
120524	110	-	
120804	125	-	
121844	160	-	
123934	200	-	
Guiding clamp					
122654	40	-	
120534	50	-	
120544	75	-	
122064	90	-	
120554	110	-	
120814	125	-	
121854	160	-	
123944	200	-	
Headless screw					
121074	M 8	-	
121084	M 10	-	

Article	Product	REECE codes	Quantity	Price	
Rubber sealing ring					
128243	40	1450887	
128013	50	1450888	
128023	75	1450889	
128003	90	-	
128033	110	1450891	
128043	125	-	
128053	160	1450893	
Rubber nipple					
126253	50/40	1450882	
121913	50/50	1450883	
Rubber nipple with bead					
122923	40/30	1450884	
122933	50/30	1450885	
122943	50/40	1450886	
Rubber sleeve adaptor					
125024	50/53-63	1450894	
125034	75/75-89	1450895	
123904	110/90	-	
123914	110/110	1450897	
Securing clip					
123000	110	1450951	
123002	160	1450952	
123006	200	-	
Lubricant					
128933	150 g	1450813	
128943	250 g	1450814	
128953	500 g	1450815	

NOTES

Horizontal lines for writing notes.

NOTES

Horizontal lines for writing notes.

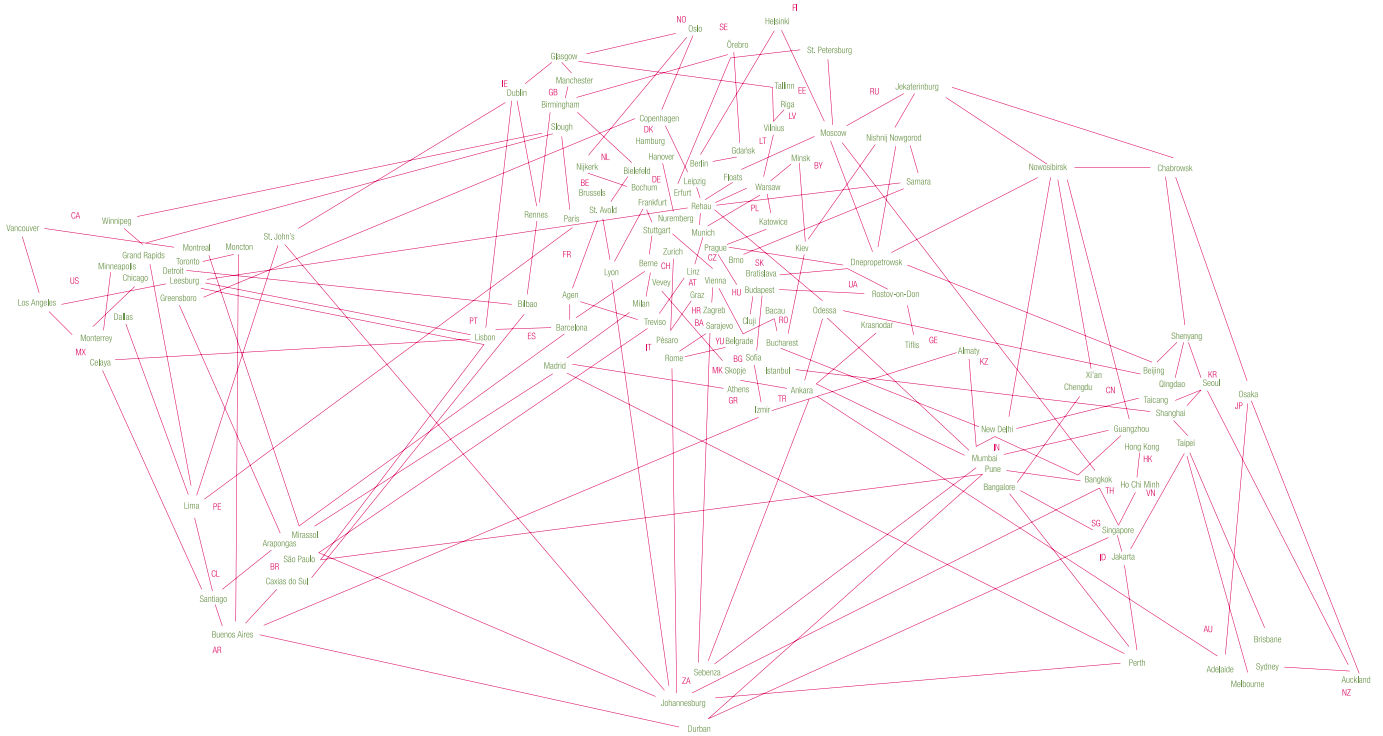

Our verbal and written advice relating to technical applications is based on experience and is to the best of our knowledge correct but is given without obligation. The use of REHAU products in conditions that are beyond our control or for applications other than those specified releases us from any obligation in regard to claims made in respect of the products. We recommend that the suitability of any REHAU product for the intended application should be checked. Utilization and processing of our products are beyond our control and are therefore exclusively your responsibility. In the event that a liability is nevertheless considered, any compensation will be limited to the value of the goods supplied by us and used by you. Our warranty assumes consistent quality of our products in accordance with our specification and in accordance with our general conditions of sale. This document is protected by copyright. All rights based on this are reserved. No part of this publication may be translated, reproduced or transmitted in any form or by any similar means, electronic or mechanical, photocopying, recording or otherwise, or stored in a data retrieval system.

REHAU Branches in Asia/Australia

Regional Office for Asia/Australia

SINGAPORE

1 King George's Avenue, REHAU Building, Singapore 208557 Tel: +65 6392-6006 Fax: +65 6392-6116

AUSTRALIA National Customer Centre Tel: 1300 768 033 Adelaide Tel: +61 8 8100-3500 Brisbane Tel: +61 7 5527-1833 Melbourne Tel: +61 3 9586-3100 Perth Tel: +61 8 9456-0700 Sydney Tel: +61 2 8741-4500 **GREATER CHINA** Beijing Tel: +86 10 6428-2956 Chengdu Tel: +86 28 8628-3218 Guangzhou Tel: +86 20 8776-0343 / 3646 Hong Kong Tel: +852 2898-7080 Qingdao Tel: +86 532 8667-8190 Shenyang Tel: +86 24 2287-5807 Taicang Tel: +86 512 5337-2815 Taipei Tel: +886 2 8780-3899 Xi'an Tel: +86 29 6859-7000 **INDIA** Bangalore Tel: +91 80 2222-0014 ~ 0015 Mumbai Tel: +91 22 6148-5858 New Delhi Tel: +91 11 4504-4700 ~ 4705 Pune Tel: +91 21 3530-4801 **INDONESIA** Jakarta Tel: +62 21 5275-177 **JAPAN** Tokyo Tel: +81 3 5796-2102 **KOREA** Seoul Tel: +82 2 5011-656 **NEW ZEALAND** Auckland Tel: +64 9 2722-264 **THAILAND** Bangkok Tel: +66 2 7443-155 **VIETNAM** Ho Chi Minh City Tel: +84 8 3823-3030